

High-Speed Balanced Photoreceiver

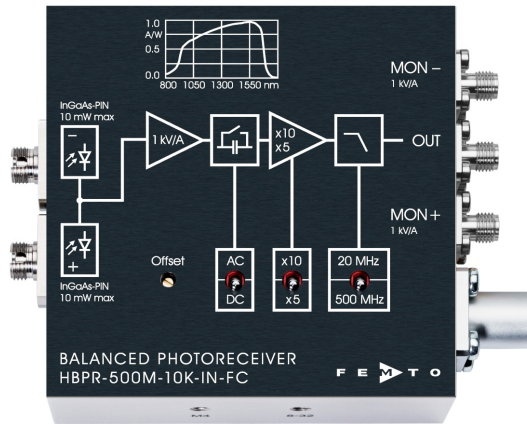

Features

- **Bandwidth DC to 500 MHz**
- **Common-Mode Rejection Ratio (CMRR) 45 dB typ.**
- **InGaAs-PIN photodiodes**
- **FC fiber optic inputs**
- **Spectral range 900 – 1700 nm**
- **Very low NEP, down to 6.7 pW/√Hz**
- **Transimpedance gain switchable 5×10^3 V/A, 10×10^3 V/A**
- **High dynamic input range up to 2×10 mW balanced optical power**
- **Fast monitor outputs with 10 MHz bandwidth and 1×10^3 V/A gain**
- **Switchable low pass filter for minimizing wideband noise**
- **UNC 8-32 and M4 tapped holes for mounting on standard posts with metric and imperial thread**

Applications

- **Spectroscopy**
- **Heterodyne detection**
- **Optical coherence tomography (OCT)**
- **Optical delay measurement**
- **Differential optical front-end for oscilloscopes, spectrum analyzers, A/D converters and RF lock-in amplifiers**

Block Diagram

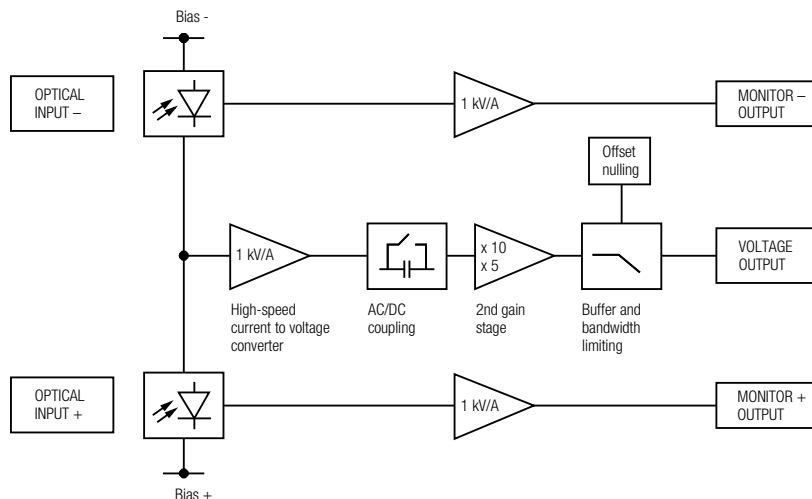

BS-HBPR_R2

High-Speed Balanced Photoreceiver

Intended Use

The HBPR-500M-10K-IN-FC photoreceiver consists of a combination of two anti-parallel connected photodiodes with a subsequent low-noise transimpedance amplifier. It is designed for fast conversion of the tiny difference of two optical signals into an equivalent output voltage. Operation is mostly self-explanatory. If in doubt, consult this document or contact support@femto.de.

For safe operation, please refer to the damage thresholds specified in the "Absolute Maximum Ratings", "Temperature Range" and "Power Supply" sections of this document.

The operating environment must be free of smoke, dust, grease, oil, condensing moisture, and other contaminants that could affect the operation or performance.

Application Notes

The damage threshold of 12 mW for each photodiode mentioned in the "Absolute Maximum Ratings" section applies to reasonably homogeneous illumination of the photodiodes. Extreme focusing of the light beam can lead to damage to the photodiodes, even at significantly lower light power.

To achieve optimum performance, it is recommended that the CW light intensity at both inputs be well balanced. The monitor outputs can be used for continuous balance control. For setups with arbitrarily varying CW offset, the photoreceiver's AC mode can be helpful. Using AC mode increases the CW offset range to 1.3 mW (@ 1550 nm), regardless of the gain setting.

Available Version

HBPR-500M-10K-IN-FC



Fix/permanent FC fiber connectors for high coupling efficiency, excellent conversion gain accuracy and common mode rejection ratio (CMRR)

Related Models

Various free space or fiber coupled HBPR models, with bandwidth up to 500 MHz, in the spectral range from 320 nm to 1700 nm are available.

Si Versions

- Fiber-coupled with fix/permanent FC fiber connectors
- | | |
|---------------------|--|
| HBPR-100M-60K-SI-FC | Si-PIN Ø 0.8 mm, DC – 100 MHz, 320 – 1000 nm, CMRR 50 dB, gain $2.0 \times 10^4 / 6.0 \times 10^4$ V/A switchable |
| HBPR-200M-30K-SI-FC | Si-PIN Ø 0.8 mm, DC – 200 MHz, 320 – 1000 nm, CMRR 45 dB, gain $1.0 \times 10^4 / 3.0 \times 10^4$ V/A switchable |
| HBPR-500M-10K-SI-FC | Si-PIN Ø 0.4 mm, DC – 500 MHz, 320 – 1000 nm, CMRR 40 dB, gain $5.0 \times 10^3 / 10.0 \times 10^3$ V/A switchable |
- Free space versions with 1.035"-40 threaded flanges
- | | |
|----------------------|--|
| HBPR-100M-60K-SI-FST | Si-PIN Ø 0.8 mm, DC – 100 MHz, 320 – 1000 nm, CMRR 50 dB, gain $2.0 \times 10^4 / 6.0 \times 10^4$ V/A switchable |
| HBPR-200M-30K-SI-FST | Si-PIN Ø 0.8 mm, DC – 200 MHz, 320 – 1000 nm, CMRR 45 dB, gain $1.0 \times 10^4 / 3.0 \times 10^4$ V/A switchable |
| HBPR-500M-10K-SI-FST | Si-PIN Ø 0.4 mm, DC – 500 MHz, 320 – 1000 nm, CMRR 40 dB, gain $5.0 \times 10^3 / 10.0 \times 10^3$ V/A switchable |

High-Speed Balanced Photoreceiver

<p>Related Models (continued)</p> <p>InGaAs Versions</p>	<p>Fiber-coupled with fix/permanent FC fiber connectors (ball lense coupled)</p> <p>HBPR-100M-60K-IN-FC InGaAs-PIN \varnothing 0.08 mm, DC – 100 MHz, 900 – 1700 nm, CMRR 55 dB, gain $2.0 \times 10^4 / 6.0 \times 10^4$ V/A switchable</p> <p>HBPR-200M-30K-IN-FC InGaAs-PIN \varnothing 0.08 mm, DC – 200 MHz, 900 – 1700 nm, CMRR 50 dB, gain $1.0 \times 10^4 / 3.0 \times 10^4$ V/A switchable</p> <p>Free space versions with 1.035"-40 threaded flanges</p> <p>HBPR-100M-60K-IN-FST InGaAs-PIN \varnothing 0.3 mm, DC – 100 MHz, 800 – 1700 nm, CMRR 50 dB, gain $2.0 \times 10^4 / 6.0 \times 10^4$ V/A switchable</p> <p>HBPR-200M-30K-IN-FST InGaAs-PIN \varnothing 0.3 mm, DC – 200 MHz, 800 – 1700 nm, CMRR 45 dB, gain $1.0 \times 10^4 / 3.0 \times 10^4$ V/A switchable</p> <p>HBPR-450M-10K-IN-FST InGaAs-PIN \varnothing 0.3 mm, DC – 450 MHz, 800 – 1700 nm, CMRR 35 dB, gain $5.0 \times 10^3 / 10.0 \times 10^3$ V/A switchable</p>
<p>Available Accessory</p>	<p>PS-15-25-L  Power Supply Input: 100 – 240 VAC Output: ± 15 VDC</p>
<p>Specifications</p> <p>Gain</p> <p>Frequency Response</p> <p>Time Response</p> <p>Input</p> <p>Detector</p>	<p>Test conditions $V_s = \pm 15$ V, $T_A = 25$ °C, output load impedance 50Ω, warm-up 20 minutes (min. 10 minutes recommended), monitor outputs terminated with $1 M\Omega$</p> <p>Transimpedance gain 5×10^3 V/A (@ 2nd gain $\times 5$, 50Ω load) 10×10^3 V/A (@ 2nd gain $\times 10$, 50Ω load)</p> <p>Gain accuracy ± 1 % electrical</p> <p>Conversion gain 4.75×10^3 V/W typ. (@ 2nd gain $\times 5$, 1550 nm, 50Ω load) 9.5×10^3 V/W typ. (@ 2nd gain $\times 10$, 1550 nm, 50Ω load)</p> <p>Common mode rejection ratio (CMRR) 55 dB typ. ($f \leq 100$ MHz) 45 dB typ. ($f \leq 500$ MHz)</p> <p>Lower cut-off frequency DC / 10 Hz, switchable</p> <p>Upper cut-off frequency (-3 dB) 500 MHz / 20 MHz, switchable</p> <p>Rise/fall time (10 % – 90 %) 0.78 ns (@ 2nd gain $\times 5$); 0.9 ns (@ 2nd gain $\times 10$) 17.5 ns (@ bandwidth set to 20 MHz)</p> <p>Noise equivalent power (NEP) minimum 6.7 pW/$\sqrt{\text{Hz}}$ (@ 1550 nm) 6.9 pW/$\sqrt{\text{Hz}}$ (@ 1550 nm, 20 MHz) 15.0 pW/$\sqrt{\text{Hz}}$ (@ 1550 nm, 200 MHz) 28.0 pW/$\sqrt{\text{Hz}}$ (@ 1550 nm, 500 MHz)</p> <p>Maximum differential CW power (for linear amplification) 210 μW (@ 2nd gain $\times 5$, DC-coupled, 1550 nm) 105 μW (@ 2nd gain $\times 10$, DC-coupled, 1550 nm) 1.3 mW (@ AC-coupled, 1550 nm)</p> <p>Max. optical CW balanced power (common mode power) 10 mW (on each photodiode, @ 1550 nm)</p> <p>Monitor optical saturation power (limited by linear amplification) 10.5 mW (@ 1550 nm)</p> <p>Detector type InGaAs-PIN photodiode in FC fiber connector</p> <p>Active area $\varnothing 80 \mu\text{m}$, integrated ball lens, suitable for fibers up to $50 \mu\text{m}$ core diameter</p> <p>Spectral range 900 – 1700 nm</p> <p>Sensitivity 0.95 A/W typ. (@ 1550 nm)</p>

High-Speed Balanced Photoreceiver

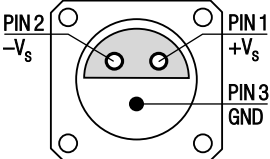
Specifications (continued)		
Output	Output voltage range Max. output voltage Offset voltage compensation Output impedance Slew rate Max. output current Output reflection S22 Output noise (typ.)	± 1.0 V (@ 50 Ω load) for linear operation and low harmonic distortion ± 2.0 V (@ 50 Ω load) ± 100 mV typ., adjustable by offset potentiometer 50 Ω (terminate with 50 Ω load) 2800 V/ μ s 70 mA -30 dB @ < 100 MHz -20 dB @ < 800 MHz 2.2 mV RMS (15 mV peak-peak) (@ 2 nd gain $\times 5$) 3.8 mV RMS (25 mV peak-peak) (@ 2 nd gain $\times 10$) 0.25 mV RMS (1.7 mV peak-peak) (@ 2 nd gain $\times 5$, BW 20 MHz) 0.4 mV RMS (2.7 mV peak-peak) (@ 2 nd gain $\times 10$, BW 20 MHz) (@ 50 Ω load, no signal on detectors, measurement bandwidth 2 GHz)
Monitor Outputs	Gain Voltage range Output impedance Max. output current Bandwidth Output noise	1×10^3 V/A (@ ≥ 100 k Ω load) 0 ... +10 V (@ ≥ 100 k Ω load) 50 Ω (terminate with ≥ 100 k Ω load) 30 mA typ. DC - 10 MHz 0.6 mV RMS (4 mV peak-peak) (@ 100 k Ω load, no signal on detectors, measurement bandwidth 200 MHz)
Power Supply	Supply voltage Supply current	± 15 V (± 14.5 V ... ± 16.5 V) -90 / +120 mA typ. (depends on operating conditions, recommended power supply capability min. ± 200 mA)
Optical Input Connector	Material FC receptacle	nickel silver
Case	Weight Material	350 g (0.77 lbs) AlMg3Mn, nickel-plated
Temperature Range	Storage temperature Operating temperature	-40 $^{\circ}$ C ... +85 $^{\circ}$ C 0 $^{\circ}$ C ... +60 $^{\circ}$ C
Absolute Maximum Ratings	Optical input power (CW) Power supply voltage	12 mW (on each photodiode) ± 20 V
Connectors	Inputs Outputs Power supply	FC fiber optic connectors (FC/PC and FC/APC compatible) SMA jacks (female) LEMO [®] series 1S, 3-pin fixed socket (mating plug type: FFA.1S.303.CLAC52)
		 <p>Pin 1: +15 V Pin 2: -15 V Pin 3: GND</p>
Scope of Delivery	HBPR-500M-10K-IN-FC, Lemo [®] 3-pin connector, 3 \times adapter SMA (male) to BNC (female), datasheet	
Ordering Information	HBPR-500M-10K-IN-FC	FC fiber optic connectors (FC/PC and FC/APC compatible)

High-Speed Balanced Photoreceiver

Spectral Response

HBPR-500M-10K-IN-FC (FC fiber optic input)

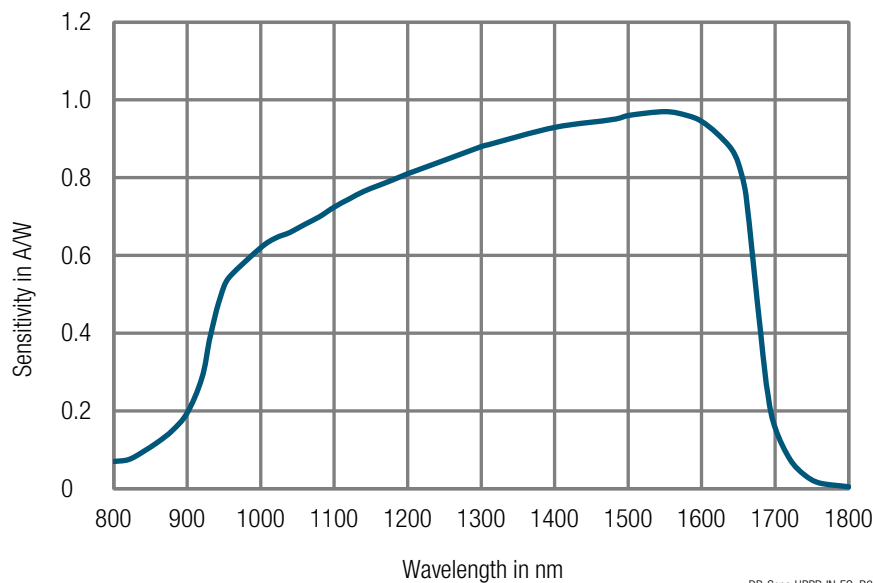

DB-Sens-HBPR-IN-FC_R2

High-Speed Balanced Photoreceiver

Dimensions

HBPR-500M-10K-IN-FC

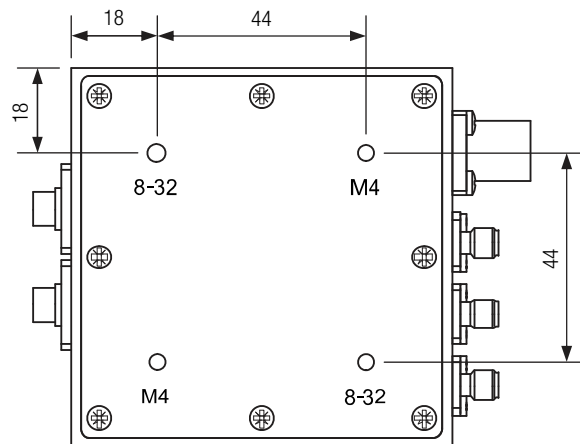
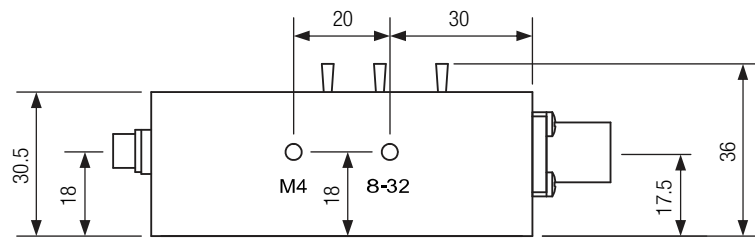
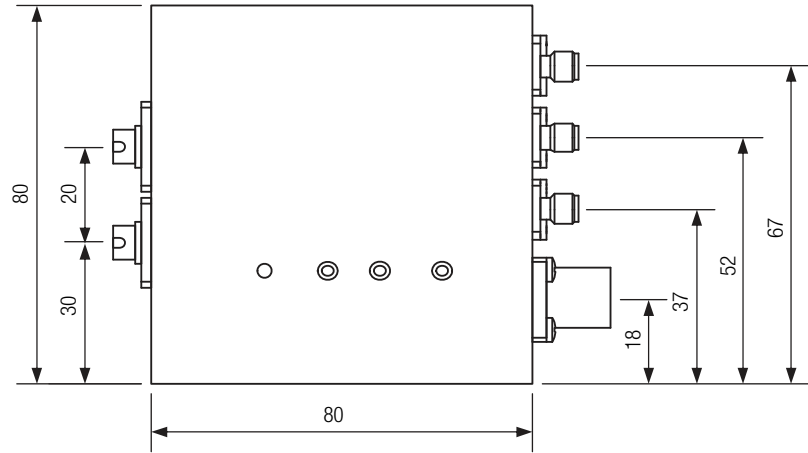

DZ-HBPR_FC_R2

all dimensions in mm unless otherwise noted

The base plate can be rotated if necessary. To do this, loosen the 8 screws.

FEMTO Messtechnik GmbH
 Klosterstr. 64
 10179 Berlin · Germany
 Phone: +49 30 280 4711-0
 Fax: +49 30 280 4711-11
 Email: info@femto.de
 www.femto.de

Specifications are subject to change without notice. Information provided herein is believed to be accurate and reliable. However, no responsibility is assumed by FEMTO Messtechnik GmbH for its use, nor for any infringement of patents or other rights of third parties which may result from its use. No license is granted by implication or otherwise under any patent or patent rights of FEMTO Messtechnik GmbH. Product names mentioned may also be trademarks used here for identification purposes only.

© by FEMTO Messtechnik GmbH · Printed in Germany